

The MCS108K series of current sensors is suitable for all markets, including automotive, industrial, commercial, and communication system applications, and the current sensing of AC and DC provides a smaller, more cost-effective solution with multiple output modes.

## Features and Benefits

- Open-loop current sensor using Hall effect IC
- Single 5V supply
- Support unidirectional, bidirectional output,
- Analog signal output
- Current detection range:  $\pm 10A - \pm 50A$
- Operating temperature range :  $-40^{\circ}C$  to  $+125^{\circ}C$
- QVO (Zero current output) :
  - xR : QVO ratiometric to supply voltage  $V_{CC}$  , Fixed Gain  $V_{QVO}=V_{CC}/2$  or  $V_{CC}/10$
- Differential Hall sensor, good accuracy, linearity and temperature drift
- Low internal resistance, can effectively control the heat dissipation and power consumption

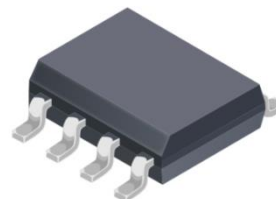

## Application

- EV/HEV motor controller
- frequency converters
- DC/DC

## Typical Application Circuit

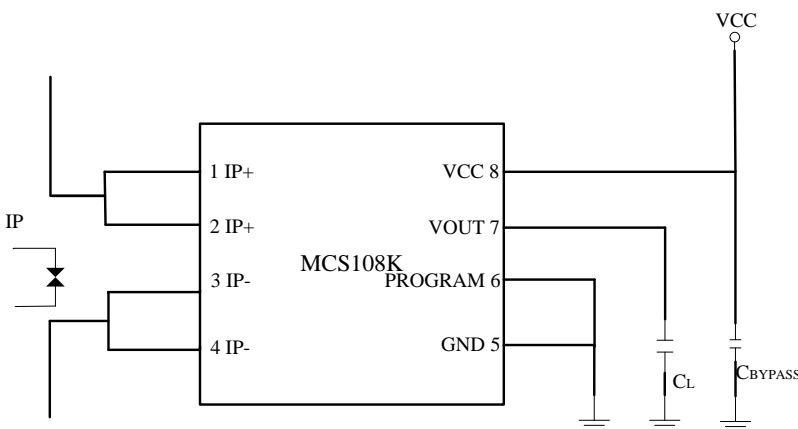

\*Vcc BYPASS capacitor must be close to device Vcc pin

\*Vout BYPASS capacitor must be close to device Vout pin

*Pin diagram*

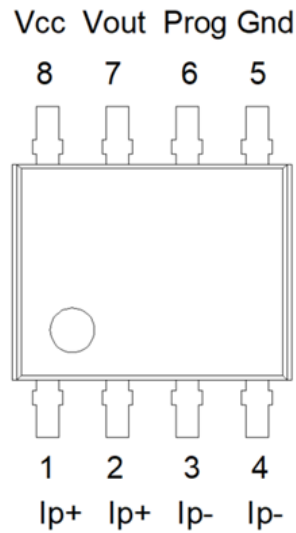

Pin number	name	description
1,2	IP+	Positive terminals for current being sensed(enter)
3,4	IP-	Negative terminals for current being sensed(out)
5	GND	Ground terminal
6	PROGRA M	Factory calibrated feet (grounded recommended)
7	VOUT	Analog output
8	VCC	Power supply terminal

## Ordering Information

M C S XXX X- XXX X X

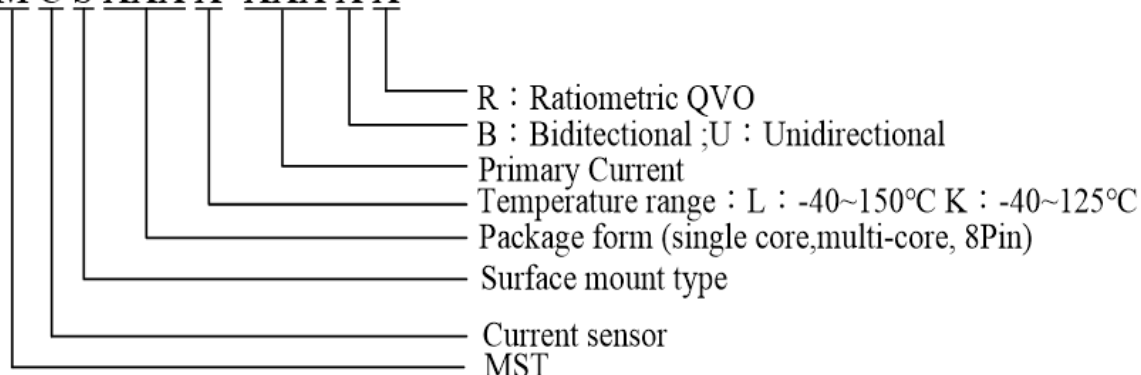

Part Number	QVO V <sub>OUT</sub> (Q) (V)	Primary Current I <sub>P</sub> (A)	Sensitivity Sens <sub>(Typ.)</sub> (mV/A)	TA (°C)	MPQ (PCS)
MCS108K-010BR	V <sub>CC</sub> /2	±10	200	-40~125	1000
MCS108K-020BR	V <sub>CC</sub> /2	±20	100	-40~125	1000
MCS108K-020UR	V <sub>CC</sub> /10	20	200	-40~125	1000
MCS108K-030BR	V <sub>CC</sub> /2	±30	66.7	-40~125	1000
MCS108K-030UR	V <sub>CC</sub> /10	30	133.3	-40~125	1000
MCS108K-050BR	V <sub>CC</sub> /2	±50	40	-40~125	1000
MCS108K-050UR	V <sub>CC</sub> /10	50	80	-40~125	1000

\*Please contact factory for currents other than standard current specifications

## Absolute Maximum Ratings

Characteristic	Symbol	Rating	Unit
Supply Voltage	V <sub>CC</sub>	-0.3 to 6.5	V
Supply Current	I <sub>CC</sub>	20	mA
Output Voltage/ Reference voltage	V <sub>OUT</sub>	0.15 to V <sub>CC</sub> -0.15	V
Output Current	I <sub>OUT</sub>	±40	mA
Operating Temperature	T <sub>A</sub>	-40 to 125	°C
Max Junction Temperature	T <sub>J</sub>	165	°C
Storage Temperature	T <sub>S</sub>	-55 to 150	°C

## Electrical Specifications

Dc operating parameters at VCC = 5.0V (unless otherwise stated), TA within the specified temperature range.

Parameter	Symbol	Condition	Min	Typ.	Max	Unit
Supply Voltage	VCC		4.5	5.0	5.5	V
Supply Current	ICC	RL ≥ 10KΩ		16		mA
Power on Delay	TPO	TA=25°C			1000	μs
QVO Ratiometric Error (-R)	Er		-0.3		0.3	%
Zero Current Output Voltage	VQVO	MCS108K-xxxBR	VCC/2			V
		MCS108K-xxxUR	VCC/10			
Output voltage Range @Ip	VOUT-VQVO	MCS108K-xxxBR	±2			
		MCS108K-xxxUR	4			
Output Load Resistance	RL	VOUT to VCC or GND	5			KΩ
Output Load Capacitance	CL	VOUT TO GND			10	nF
Response Time	tRESPONSE	TA=25°C, CL=1nF, Ip step=50% of Ip+, 90% input to 90% output		1		μs
Internal Bandwidth	BW	Small signal -3dB, CL=1nF, TA=25°C		0.7	1	MHz
DC Output Impedance	ROUT	TA = 25°C			20	KΩ

## Isolation Characteristics

Characteristic	Symbol	Notes	Rating	Unit
Dielectric Strength Test Voltage	VISO	Agency type-tested for 60 seconds per UL standard 60950-1, 2nd Edition	2400	VAC
Working Voltage for Basic Isolation	VWFSI	According to UL Standard 60950-1 2nd Edition, Basic (Single) Isolation	420	VDC or Vpk
			297	Vrms
Electrical distance	DCL	Minimum distance from IP pin to signal pin (air)	4.2	mm
Creepage distance	DCR	Minimum distance from IP pin to signal pin (plastic body)	4.2	mm

\*1 : 60-second test is only for UL test; Tested in production against UL60950-1 2nd Edition

## MCS108K-010BR Performance Characteristics

Dc operating parameters at  $V_{CC} = 5.0V$ ,  $T_A = -40^{\circ}C \sim 125^{\circ}C$ , unless other wise specified

Parameter	Symbol	Condition	Min	Typ.	Max	Unit
<b>Nominal parameters</b>						
Current Sensing Range	$I_P$		-10		10	A
Sensitivity	$Sens_{TA}$	@ $V_{CC}=5.0V$		200		mV/A
Zero-current output voltage	$V_{QVO}$	$I_P=0A$		$V_{CC}/2$		V
<b>Accuracy Performance</b>						
Sensitivity Error	$E_{Sens}$	@ $T_A=25^{\circ}C; V_{CC}=5.0V$	-1		1	%
Electrical Offset Error	$V_{OE}$	$I_P=0A, T_A=25^{\circ}C$	-10	$\pm 5$	10	mV
		$I_P=0A, T_A=-40^{\circ}C \sim 125^{\circ}C$	-30	$\pm 15$	30	mV
Linearity Error	$Lin_{ERR}$	Of full rang	-1	0.5	1	%
Total Output Error	$E_{TOT(HT)}$	Full scale of $I_P$ , $T_A=25^{\circ}C \sim 125^{\circ}C$	-2		2	%
	$E_{TOT(HT)}$	Full scale of $I_P$ , $T_A=25^{\circ}C \sim 85^{\circ}C$	-1.5		1.5	%
	$E_{TOT(LT)}$	Full scale of $I_P, T_A=-40^{\circ}C \sim 25^{\circ}C$		$\pm 3$		%

## MCS108K-020BR Performance Characteristics

Dc operating parameters at  $V_{CC} = 5.0V$ ,  $T_A = -40^{\circ}C \sim 125^{\circ}C$ , unless other wise specified

Parameter	Symbol	Condition	Min	Typ.	Max	Unit
<b>Nominal parameters</b>						
Current Sensing Range	$I_P$		-20		20	A
Sensitivity	$Sens_{TA}$	@ $V_{CC}=5.0V$		100		mV/A
Zero-current output voltage	$V_{QVO}$	$I_P=0A$		$V_{CC}/2$		V
<b>Accuracy Performance</b>						
Sensitivity Error	$E_{Sens}$	@ $T_A=25^{\circ}C; V_{CC}=5.0V$	-1		1	%
Electrical Offset Error	$V_{OE}$	$I_P=0A, T_A=25^{\circ}C$	-10	$\pm 5$	10	mV
		$I_P=0A, T_A=-40^{\circ}C \sim 125^{\circ}C$	-30	$\pm 15$	30	mV
Linearity Error	$Lin_{ERR}$	Of full rang	-1	0.5	1	%
Total Output Error	$E_{TOT(HT)}$	Full scale of $I_P$ , $T_A=25^{\circ}C \sim 125^{\circ}C$	-2		2	%
	$E_{TOT(HT)}$	Full scale of $I_P$ , $T_A=25^{\circ}C \sim 85^{\circ}C$	-1.5		1.5	%
	$E_{TOT(LT)}$	Full scale of $I_P, T_A=-40^{\circ}C \sim 25^{\circ}C$		$\pm 3$		%

## MCS108K-020UR Performance Characteristics

Dc operating parameters at  $V_{CC} = 5.0V$ ,  $T_A = -40^{\circ}C \sim 125^{\circ}C$ , unless otherwise specified

Parameter	Symbol	Condition	Min	Typ.	Max	Unit
<b>Nominal parameters</b>						
Current Sensing Range	$I_P$		0		20	A
Sensitivity	$Sens_{TA}$	@ $V_{CC}=5.0V$		200		mV/A
Zero-current output voltage	$V_{QVO}$	$I_P=0A$		$V_{CC}/10$		V
<b>Accuracy Performance</b>						
Sensitivity Error	$E_{Sens}$	@ $T_A=25^{\circ}C; V_{CC}=5.0V$	-1		1	%
Electrical Offset Error	$V_{OE}$	$I_P=0A, T_A=25^{\circ}C$	-10	$\pm 5$	10	mV
		$I_P=0A, T_A=-40^{\circ}C \sim 125^{\circ}C$	-30	$\pm 15$	30	mV
Linearity Error	$Lin_{ERR}$	Of full rang	-1	0.5	1	%
Total Output Error	$E_{TOT(HT)}$	Full scale of $I_P$ , $T_A=25^{\circ}C \sim 125^{\circ}C$	-2		2	%
	$E_{TOT(HT)}$	Full scale of $I_P$ , $T_A=25^{\circ}C \sim 85^{\circ}C$	-1.5		1.5	%
	$E_{TOT(LT)}$	Full scale of $I_P$ , $T_A=-40^{\circ}C \sim 25^{\circ}C$		$\pm 3$		%

## MCS108K-030BR Performance Characteristics

Dc operating parameters at  $V_{CC} = 5.0V$ ,  $T_A = -40^{\circ}C \sim 125^{\circ}C$ , unless otherwise specified

Parameter	Symbol	Condition	Min	Typ.	Max	Unit
<b>Nominal parameters</b>						
Current Sensing Range	$I_P$		-30		30	A
Sensitivity	$Sens_{TA}$	@ $V_{CC}=5.0V$		66.7		mV/A
Zero-current output voltage	$V_{QVO}$	$I_P=0A$		$V_{CC}/2$		V
<b>Accuracy Performance</b>						
Sensitivity Error	$E_{Sens}$	@ $T_A=25^{\circ}C; V_{CC}=5.0V$	-1		1	%
Electrical Offset Error	$V_{OE}$	$I_P=0A, T_A=25^{\circ}C$	-10	$\pm 5$	10	mV
		$I_P=0A, T_A=-40^{\circ}C \sim 125^{\circ}C$	-30	$\pm 15$	30	mV
Linearity Error	$Lin_{ERR}$	Of full rang	-1	0.5	1	%
Total Output Error	$E_{TOT(HT)}$	Full scale of $I_P$ , $T_A=25^{\circ}C \sim 125^{\circ}C$	-2		2	%
	$E_{TOT(HT)}$	Full scale of $I_P$ , $T_A=25^{\circ}C \sim 85^{\circ}C$	-1.5		1.5	%
	$E_{TOT(LT)}$	Full scale of $I_P$ , $T_A=-40^{\circ}C \sim 25^{\circ}C$		$\pm 3$		%

## MCS108K-030UR Performance Characteristics

Dc operating parameters at  $V_{CC} = 5.0V$ ,  $T_A = -40^{\circ}C \sim 125^{\circ}C$ , unless otherwise specified

Parameter	Symbol	Condition	Min	Typ.	Max	Unit
<b>Nominal parameters</b>						
Current Sensing Range	$I_P$		0		30	A
Sensitivity	$Sens_{TA}$	@ $V_{CC}=5.0V$		133.3		mV/A
Zero-current output voltage	$V_{QVO}$	$I_P=0A$		$V_{CC}/10$		V
<b>Accuracy Performance</b>						
Sensitivity Error	$E_{Sens}$	@ $T_A=25^{\circ}C; V_{CC}=5.0V$	-1		1	%
Electrical Offset Error	$V_{OE}$	$I_P=0A, T_A=25^{\circ}C$	-10	$\pm 5$	10	mV
		$I_P=0A, T_A=-40^{\circ}C \sim 125^{\circ}C$	-30	$\pm 15$	30	mV
Linearity Error	$Lin_{ERR}$	Of full rang	-1	0.5	1	%
Total Output Error	$E_{TOT(HT)}$	Full scale of $I_P$ , $T_A=25^{\circ}C \sim 125^{\circ}C$	-2		2	%
	$E_{TOT(HT)}$	Full scale of $I_P$ , $T_A=25^{\circ}C \sim 85^{\circ}C$	-1.5		1.5	%
	$E_{TOT(LT)}$	Full scale of $I_P$ , $T_A=-40^{\circ}C \sim 25^{\circ}C$		$\pm 3$		%

## MCS108K-050BR Performance Characteristics

Dc operating parameters at  $V_{CC} = 5.0V$ ,  $T_A = -40^{\circ}C \sim 125^{\circ}C$ , unless otherwise specified

Parameter	Symbol	Condition	Min	Typ.	Max	Unit
<b>Nominal parameters</b>						
Current Sensing Range	$I_P$		-50		50	A
Sensitivity	$Sens_{TA}$	@ $V_{CC}=5.0V$		40		mV/A
Zero-current output voltage	$V_{QVO}$	$I_P=0A$		$V_{CC}/2$		V
<b>Accuracy Performance</b>						
Sensitivity Error	$E_{Sens}$	@ $T_A=25^{\circ}C; V_{CC}=5.0V$	-1		1	%
Electrical Offset Error	$V_{OE}$	$I_P=0A, T_A=25^{\circ}C$	-10	$\pm 5$	10	mV
		$I_P=0A, T_A=-40^{\circ}C \sim 125^{\circ}C$	-30	$\pm 15$	30	mV
Linearity Error	$Lin_{ERR}$	Of full rang	-1	0.5	1	%
Total Output Error	$E_{TOT(HT)}$	Full scale of $I_P$ , $T_A=25^{\circ}C \sim 125^{\circ}C$	-2		2	%
	$E_{TOT(HT)}$	Full scale of $I_P$ , $T_A=25^{\circ}C \sim 85^{\circ}C$	-1.5		1.5	%
	$E_{TOT(LT)}$	Full scale of $I_P$ , $T_A=-40^{\circ}C \sim 25^{\circ}C$		$\pm 3$		%

## MCS108K-050UR Performance Characteristics

Dc operating parameters at  $V_{CC} = 5.0V$ ,  $T_A = -40^{\circ}C \sim 125^{\circ}C$ , unless otherwise specified

Parameter	Symbol	Condition	Min	Typ.	Max	Unit
<b>Nominal parameters</b>						
Current Sensing Range	$I_p$		0		50	A
Sensitivity	$Sens_{TA}$	@ $V_{CC}=5.0V$		80		mV/A
Zero-current output voltage	$V_{QVO}$	$I_p=0A$		$V_{CC}/10$		V
<b>Accuracy Performance</b>						
Sensitivity Error	$E_{Sens}$	@ $T_A=25^{\circ}C; V_{CC}=5.0V$	-1		1	%
Electrical Offset Error	$V_{OE}$	$I_p=0A, T_A=25^{\circ}C$	-10	$\pm 5$	10	mV
		$I_p=0A, T_A=-40^{\circ}C \sim 125^{\circ}C$	-30	$\pm 15$	30	mV
Linearity Error	$Lin_{ERR}$	Of full rang	-1	0.5	1	%
Total Output Error	$E_{TOT(HT)}$	Full scale of $I_p$ , $T_A=25^{\circ}C \sim 125^{\circ}C$	-2		2	%
	$E_{TOT(HT)}$	Full scale of $I_p$ , $T_A=25^{\circ}C \sim 85^{\circ}C$	-1.5		1.5	%
	$E_{TOT(LT)}$	Full scale of $I_p$ , $T_A=-40^{\circ}C \sim 25^{\circ}C$		$\pm 3$		%

## Package Information

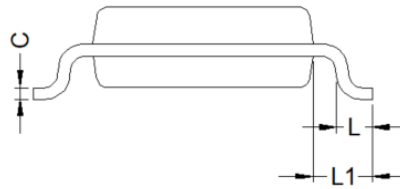
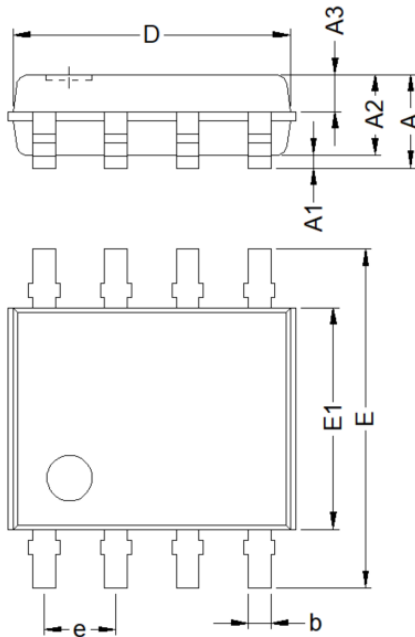

SYMBOL	MILLIMETER		
	MIN	NOM	MAX
A	--	--	1.65
A1	0.10	--	0.25
A2	1.40	1.42	1.50
A3	0.60	0.65	0.70
b	0.33	--	0.47
c	0.20	--	0.24
D	4.80	4.90	5.00
E	5.90	6.00	6.20
E1	3.85	3.90	4.00
e	1.27 (BSC)		
L	0.50	0.60	0.70
L1	1.05 (BSC)		



## Performances Parameters Definitions

- **Quiescent Voltage Output (QVO):**

In the quiescent state (no significant magnetic field,  $B=0G$ ), Current Sensor Output Voltage  $V_{QVO}$

-xR:  $V_{QVO}$  has a constant ratio to the supply voltage;

$$V_{QVO} = V_{CC}/2 \text{ or } V_{QVO} = V_{CC}/10$$

- **Sensitivity(Sens):**

Sens is the slope of the reference output line ;  $V_{OUT} = V_{QVO} + 2 \times I_P/I_{P\_MAX}$

which refers to the following, the change of current, the change of output, its relationship with current is : **Sens** =  $2/I_{P\_MAX}$

- **Offset with Temperature:**

Due to internal component tolerances and thermal considerations, the Quiescent Voltage Output (QVO) may drift from its nominal value through the operating ambient temperature ( $T_A$ ).

- **Sensitivity with temperature:**

Due to the influence of internal temperature compensation coefficient, the sensitivity will change through the whole working temperature, and be different from the expected value at room temperature.

- **Offset voltage:**

The zero offset voltage is the output voltage when the primary current is zero, with ideal value:  $V_{QVO} = V_{CC}/2$  (or  $V_{CC}/10$ ). The difference between  $V_{QVO}$  and ideal value is named Total offset voltage error. This offset error can be attributed to the zero-point offset voltage (due to the ASIC internal QVO adjusted resolution), magnetic offset, temperature drift, and hysteresis.

- **Response Time :**

The time between the primary current signals ( $I_{PN}$ ) reaches 90% of its final value and when the sensor output signal reaches 90%. See figure1.

- **Rise time :**

The time between when the sensor output reaches 10% of its final value, and when it reaches 90% of its final value. See figure2.

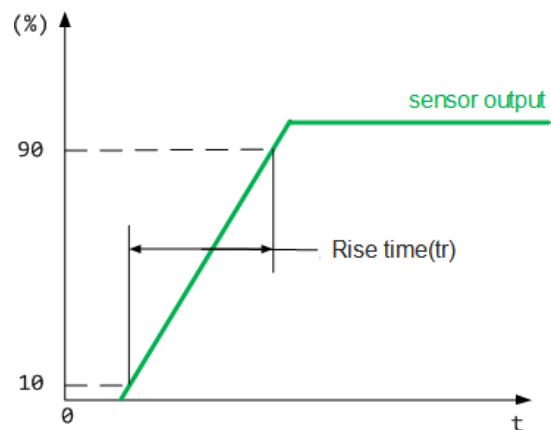
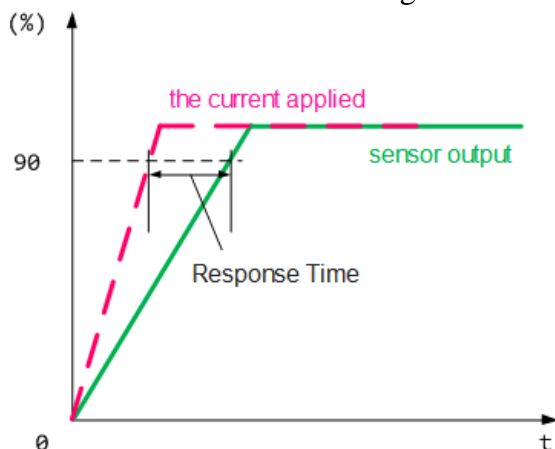

- **QVO Ratiometricity error :**

When the supply voltage  $V_{CC}$  changes from 5.0V to  $4.75 < V_{CC1} < 5.25V$ , the deviation between the sensor zero output and the theoretical value, the formula is defined as follows:

$$Er = \frac{(V_{QVO(V_{CC1})})}{V_{QVO(5.0V)} - V_{CC1}/5.0V} \times 100\%$$

- **Linearity :**

The maximum Positive and Negative error comparing with ideal output line

(-BR mode:  $V_{OUT} = V_{CC}/2 + 2 \times I_P / I_{P(MAX)}$ )

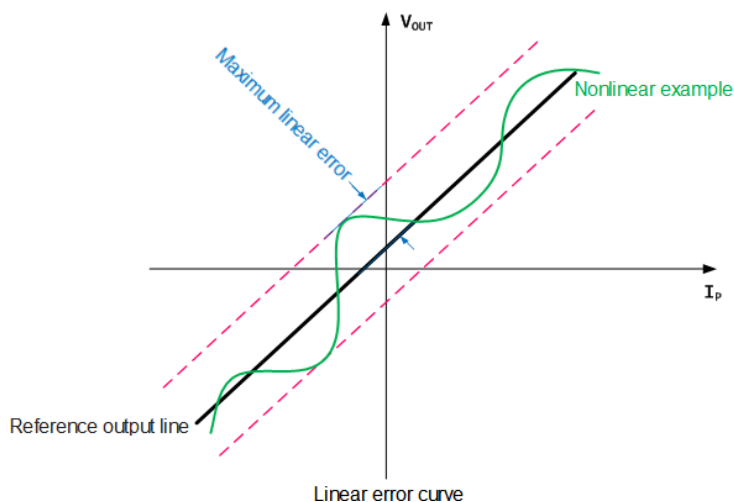

- **Total Output Error ETOT:**

Error between the device measurement current and Applied current ( $I_P$ ), which is defined as the difference between the ideal output voltage and the actual output voltage divided by the ideal sensitivity:

$$E_{TOT(I_P)} = \frac{V_{I_{OUT}(I_P)} - V_{I_{OUT}(ideal)(I_P)}}{Sens_{(ideal)} \times I_P}$$

$$V_{I_{OUT}(ideal)(I_P)} = V_{I_{OUT}(Q)} + (Sens_{(ideal)} \times I_P)$$

At relatively high currents,  $E_{TOT}$  is mainly due to sensitivity errors; while at relatively low currents,  $E_{TOT}$  is mainly due to offset voltage errors ( $V_{OE}$ ).

Actually, when the  $I_P$  approaches zero, the  $E_{TOT}$  approaches infinity due to offset voltage error.

**Important notes :**

1. Wrong wiring may cause sensor damage. After the sensor is connected to the 3.3V power supply, the measured current passes through the direction of the sensor current terminal, and the corresponding voltage value can be measured at the output end.

2. -BR:  $V_{OUT}$  is proportional to  $V_{CC}$ ,  $V_{OUT} = \frac{V_{CC}}{2} + 2 \times \frac{I_P}{I_{P(MAX)}}$   
Supply voltage change will cause  $V_{OUT}$  change by ratio.

For example:  $V_{CC}$  range 4.75V~5.25V;  $V_{QVO}$  output range at 2.375V~2.625V .

$V_{OUT(IPMAX)}$  output range at 4.275V~4.725V.